



Carport Assembling Manual

www.mombasacanvas.com

Components

4 pcs

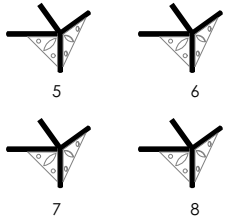
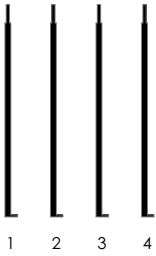

4 pcs

6 pcs

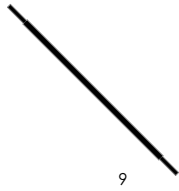

12

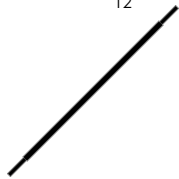

10



13



11

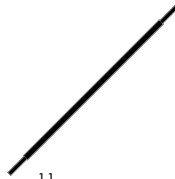

14

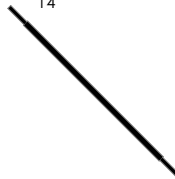

1 pcs



16



17



2 pcs

18



19



2 pcs

Easy installation guide

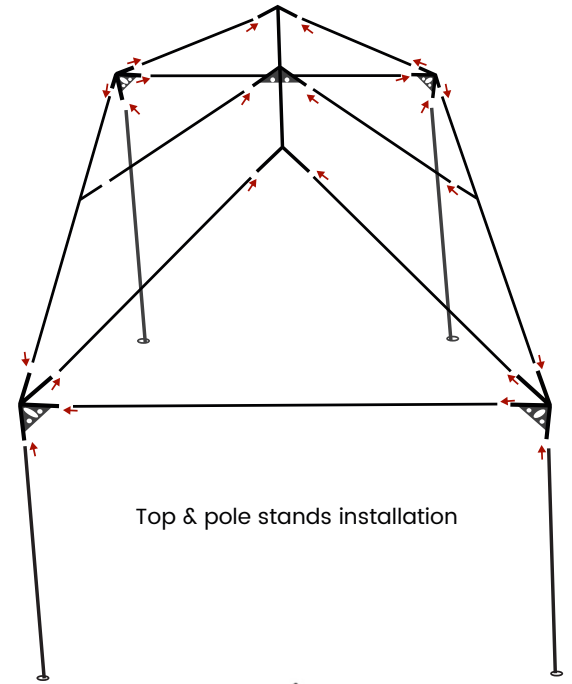
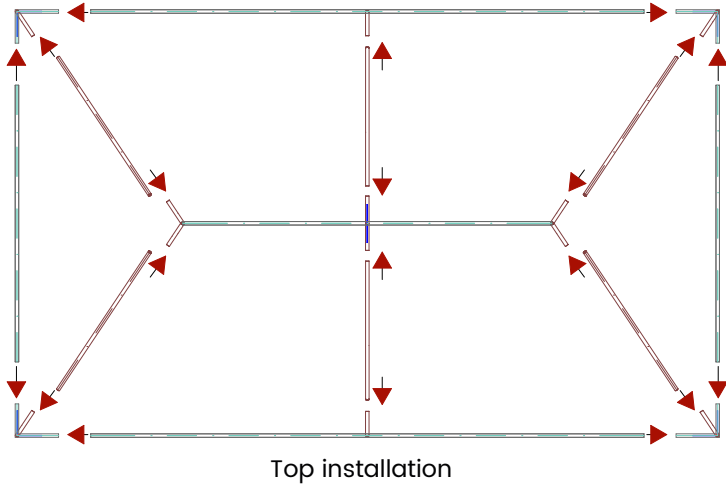

Corner angle lines assembling

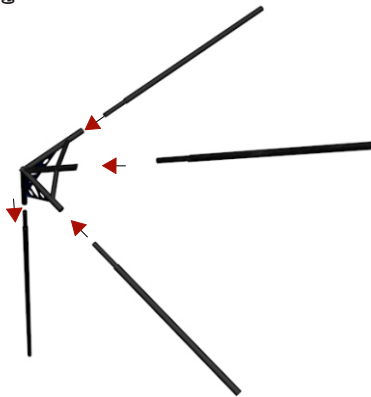
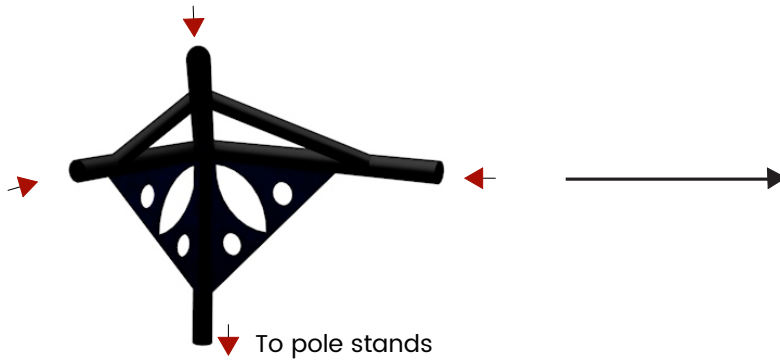

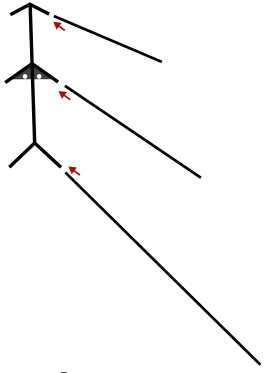

Step 1

Grab the centre metal that has 6 connection holes. Insert the 3 side metals one after the other into the holes.

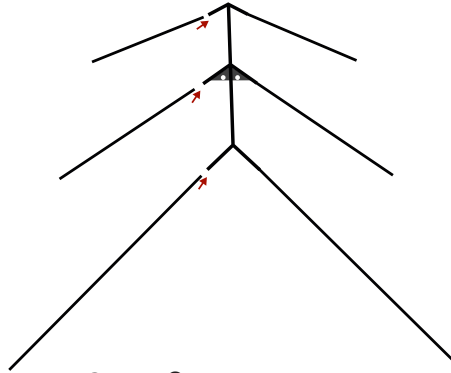

Step 2

Hold the centre metal that has 6 connection holes and insert the other 3 side metals one after the other into the holes.

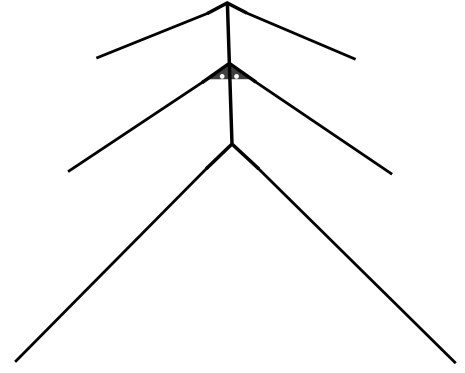

Fully installed centre pole with the 6 sides metals.

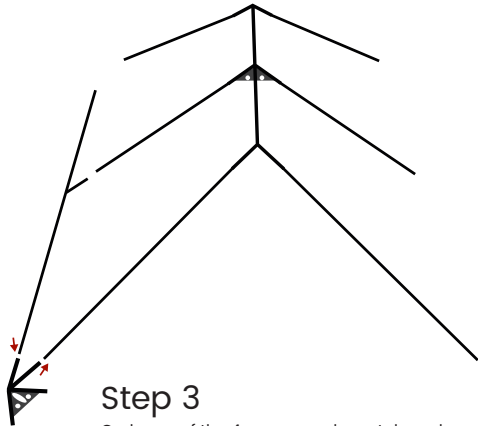

Step 3

Grab one of the 4 corner angle metals and connect it with the already installed metal from the centre pole. Connect the other metal that joins the 3 left side metals.

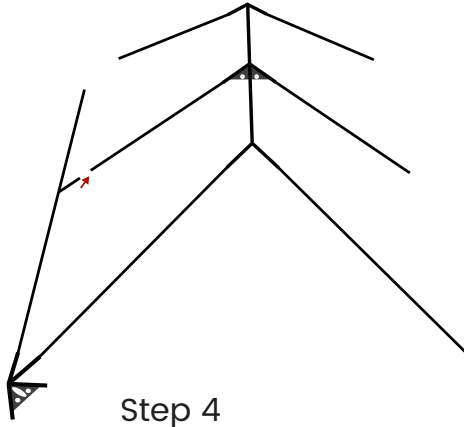

Step 4

Connect the centre connection with the second metal that is connected from the centre metal.

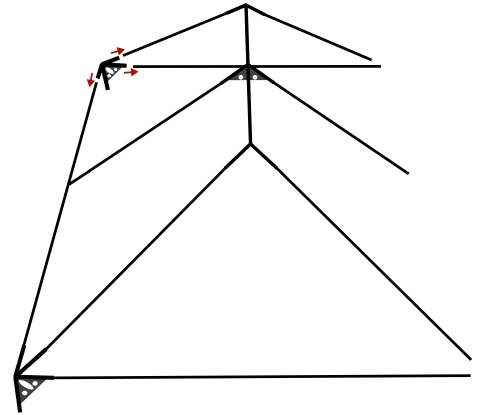

Step 5

Grab one of the second corner angle metals and connect it with the third already installed metal from the centre pole. Connect the other metal that joins the second and third corner angle.

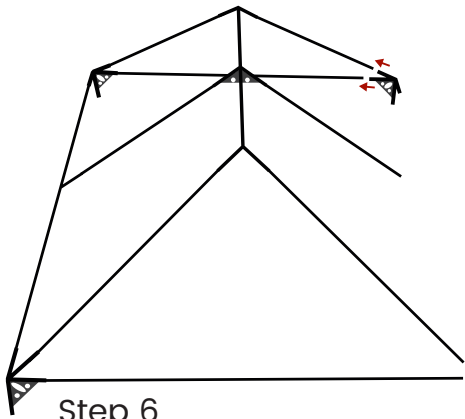

Step 6

Grab the third corner angle metals and connect it with the fourth already installed metal from the centre pole. Connect the other metal that joins the second and third corner angle.

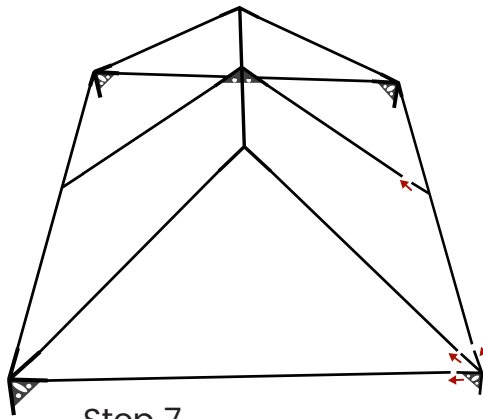

Step 7

Connect the centre connection with the fifth metal that is connected from the centre metal.

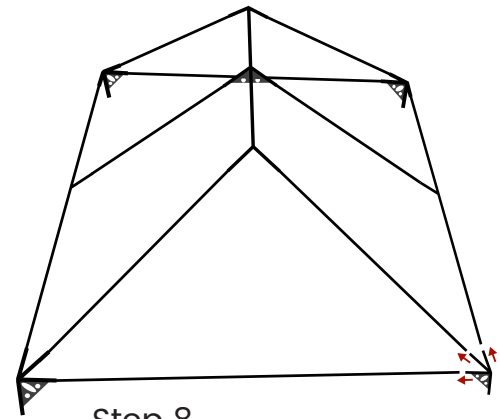

Step 8

Grab the fourth and last corner angle and connect it with the sixth already installed metal from the centre pole. Connect the other metal that joins the fourth and first corner angle.

Fitting fabric on the assembled top.



Step 9

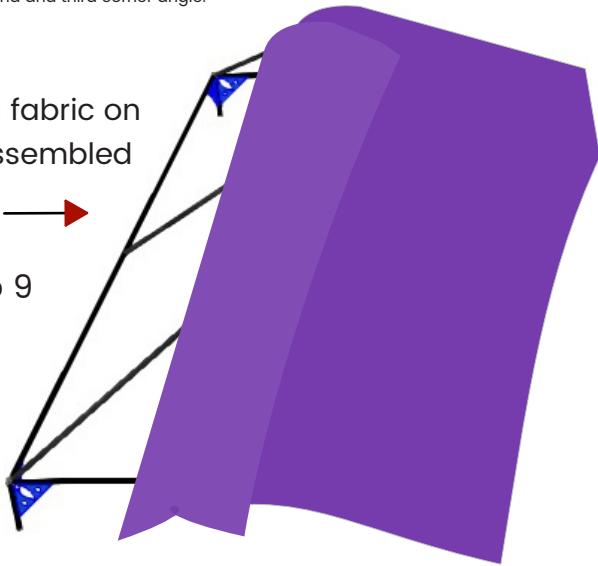

Assembled top covered with fabric

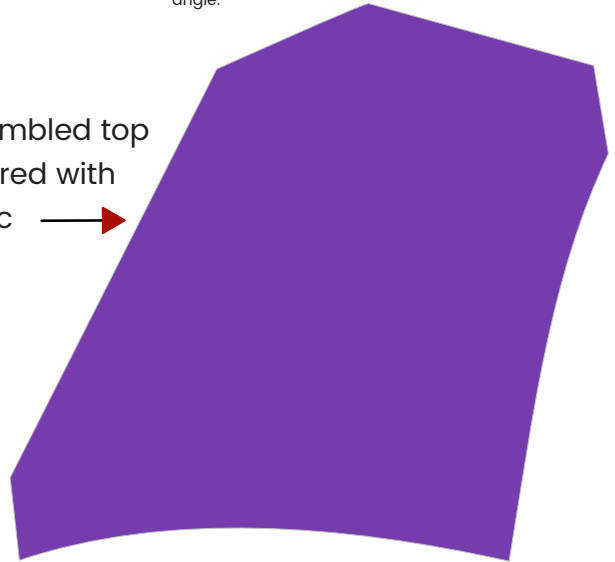

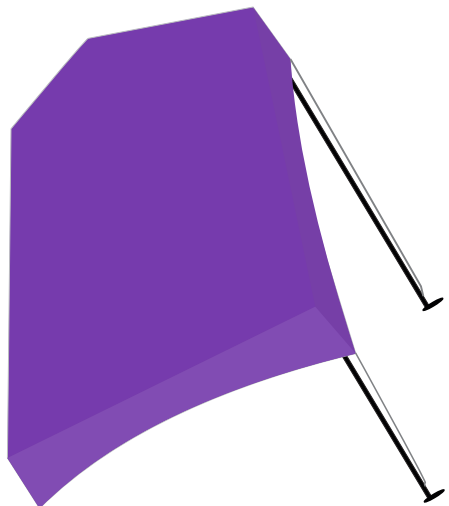

Step 10 Raise one side and fit in the two stand poles

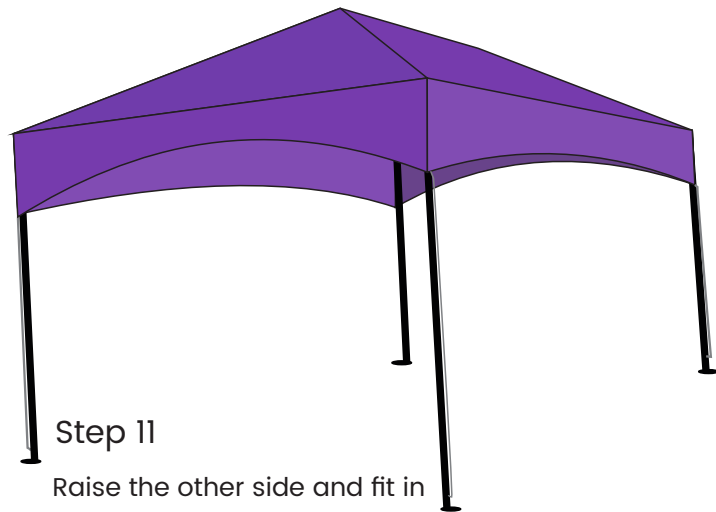

Step 11

Raise the other side and fit in the other stand poles



Step 12

after adjusting the top fabric and is well fitted, pull down the fabric ropes and hook it into the pole. Do this for the 4 poles.



Fully assembled tent with fabric

WATERPROOF SHADENET

(420GSM)

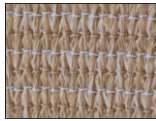

Desert Sand

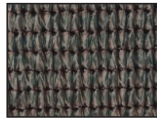

Forest Green



Black

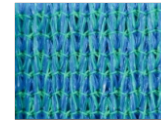

Torquoise

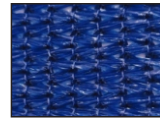

Royal Blue



Gunmetal

3Mtrs(W) x 50Mtrs(L)



Chestnut Brown

3Mtrs(W) x 50Mtrs(L)

NON WATERPROOF FABRIC

(325GSM)

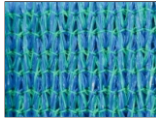

Torquoise



Silver

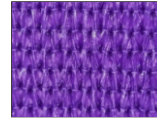

Grape

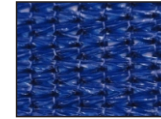

Royal Blue

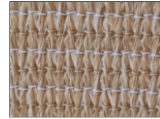

Desert Sand



Off White



Chestnut Brown

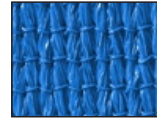

Bright Blue



Dark Green



Black



Forest Green

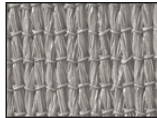

Grey

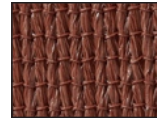

Brown



Orange

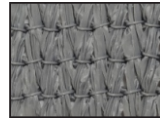

Gunmetal



Ivory

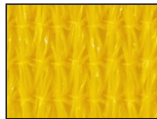

Yellow

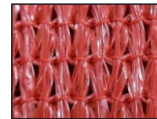

Red

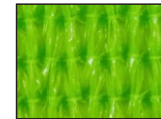

Lime Green

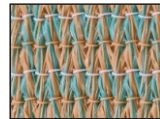

Light Green



www.mombasacanvas.com



J & A Building, Jomo Kenyatta
avenue, Mombasa



89304 - 80100 Mombasa



0720 793 857 / 0722 711 863 / 0 115 102 586



shades@mombasacanvas.com
salesdesk@mombasacanvas.com